

Standard Rectifier Module

3~ Rectifier
$V_{RRM} = 1400\text{ V}$
$I_{DAV} = 150\text{ A}$
$I_{FSM} = 1800\text{ A}$

3~ Rectifier Bridge

Part number

VUO125-14N07

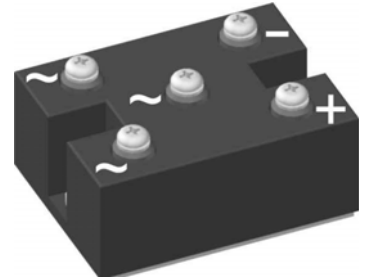

E72873



Features / Advantages:

- Package with DCB ceramic
- Improved temperature and power cycling
- Planar passivated chips
- Very low forward voltage drop
- Very low leakage current

Applications:

- Diode for main rectification
- For three phase bridge configurations
- Supplies for DC power equipment
- Input rectifiers for PWM inverter
- Battery DC power supplies
- Field supply for DC motors

Package: PWS-C

- Industry standard outline
- RoHS compliant
- Easy to mount with two screws
- Base plate: Copper internally DCB isolated
- Advanced power cycling

Rectifier				Ratings			
Symbol	Definition	Conditions	min.	typ.	max.	Unit	
V_{RSM}	max. non-repetitive reverse blocking voltage	$T_{VJ} = 25^{\circ}C$			1500	V	
V_{RRM}	max. repetitive reverse blocking voltage	$T_{VJ} = 25^{\circ}C$			1400	V	
I_R	reverse current	$V_R = 1400 V$	$T_{VJ} = 25^{\circ}C$		200	μA	
		$V_R = 1400 V$	$T_{VJ} = 150^{\circ}C$		2	mA	
V_F	forward voltage drop	$I_F = 50 A$	$T_{VJ} = 25^{\circ}C$		1.07	V	
		$I_F = 150 A$			1.34	V	
		$I_F = 50 A$	$T_{VJ} = 125^{\circ}C$		0.97	V	
		$I_F = 150 A$			1.31	V	
I_{DAV}	bridge output current	$T_C = 110^{\circ}C$ rectangular $d = \frac{1}{3}$	$T_{VJ} = 150^{\circ}C$		150	A	
V_{FO}	threshold voltage	} for power loss calculation only	$T_{VJ} = 150^{\circ}C$		0.76	V	
r_F	slope resistance				3.6	m Ω	
R_{thJC}	thermal resistance junction to case				0.6	K/W	
R_{thCH}	thermal resistance case to heatsink			0.30		K/W	
P_{tot}	total power dissipation		$T_C = 25^{\circ}C$		205	W	
I_{FSM}	max. forward surge current	$t = 10 \text{ ms}; (50 \text{ Hz}), \text{ sine}$	$T_{VJ} = 45^{\circ}C$		1.80	kA	
		$t = 8,3 \text{ ms}; (60 \text{ Hz}), \text{ sine}$	$V_R = 0 V$		1.95	kA	
		$t = 10 \text{ ms}; (50 \text{ Hz}), \text{ sine}$	$T_{VJ} = 150^{\circ}C$		1.53	kA	
		$t = 8,3 \text{ ms}; (60 \text{ Hz}), \text{ sine}$	$V_R = 0 V$		1.65	kA	
I^2t	value for fusing	$t = 10 \text{ ms}; (50 \text{ Hz}), \text{ sine}$	$T_{VJ} = 45^{\circ}C$		16.2	kA ² s	
		$t = 8,3 \text{ ms}; (60 \text{ Hz}), \text{ sine}$	$V_R = 0 V$		15.7	kA ² s	
		$t = 10 \text{ ms}; (50 \text{ Hz}), \text{ sine}$	$T_{VJ} = 150^{\circ}C$		11.7	kA ² s	
		$t = 8,3 \text{ ms}; (60 \text{ Hz}), \text{ sine}$	$V_R = 0 V$		11.3	kA ² s	
C_J	junction capacitance	$V_R = 400 V; f = 1 \text{ MHz}$	$T_{VJ} = 25^{\circ}C$		58	pF	

Package PWS-C			Ratings			
Symbol	Definition	Conditions	min.	typ.	max.	Unit
I_{RMS}	RMS current	per terminal			150	A
T_{stg}	storage temperature		-40		125	°C
T_{VJ}	virtual junction temperature		-40		150	°C
Weight				250		g
M_D	mounting torque		4.25		5.75	Nm
M_T	terminal torque		4.25		5.75	Nm
$d_{Spp/App}$	creepage distance on surface striking distance through air	terminal to terminal	26.0			mm
$d_{Spb/Apb}$		terminal to backside	14.0			mm
V_{ISOL}	isolation voltage	t = 1 second	3000			V
		t = 1 minute	2500			V

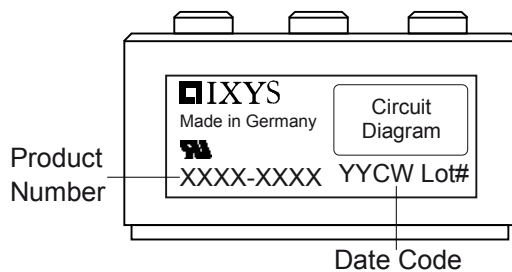

Ordering	Part Number	Marking on Product	Delivery Mode	Quantity	Code No.
Standard	VUO125-14NO7	VUO125-14NO7	Box	10	456772

Equivalent Circuits for Simulation * on die level $T_{VJ} = 150^\circ\text{C}$

Symbol	Definition	Value	Unit
V_0	threshold voltage	0.76	V
R_0	slope resistance *	2.4	mΩ

Outlines PWS-C

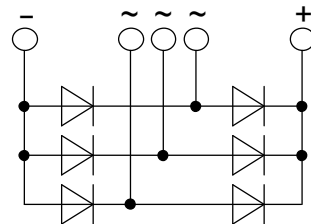
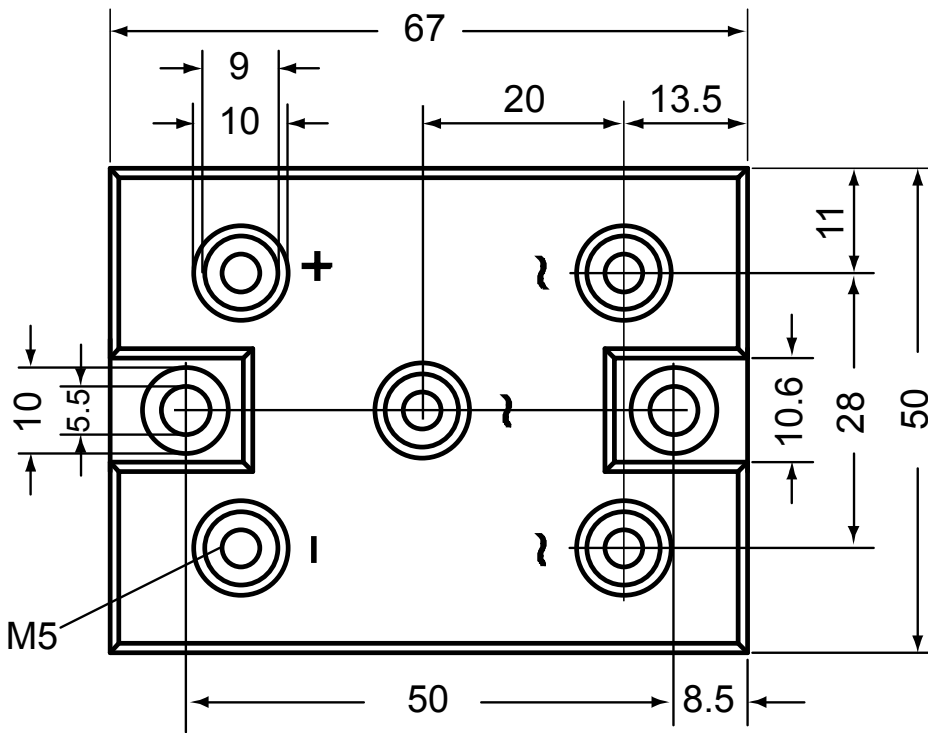
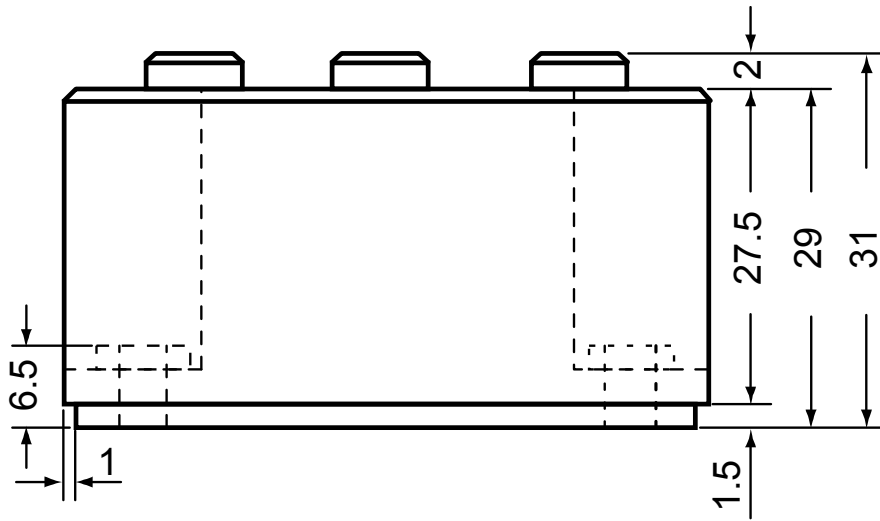

Rectifier

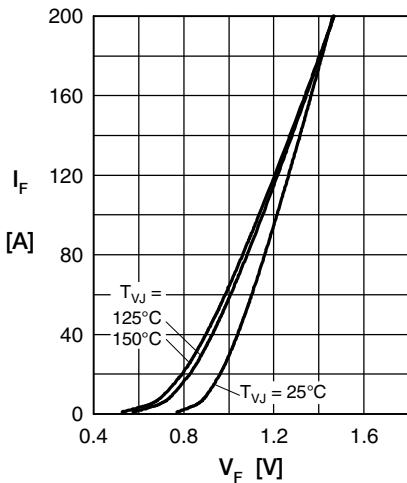

Fig. 1 Forward current versus voltage drop per diode

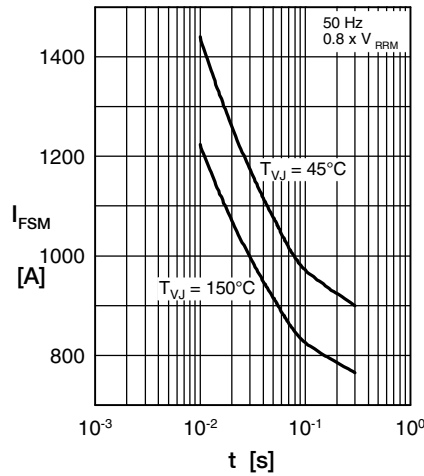

Fig. 2 Surge overload current vs. time per diode

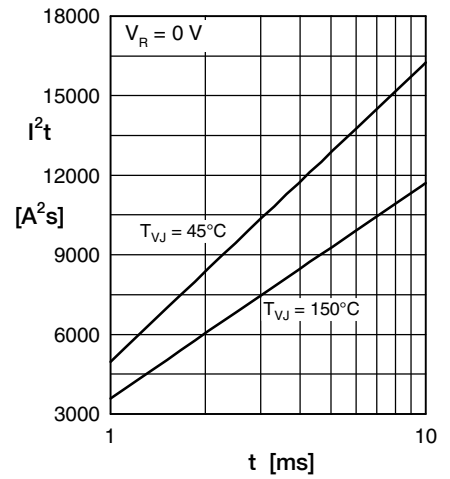

Fig. 3 I^2t versus time per diode

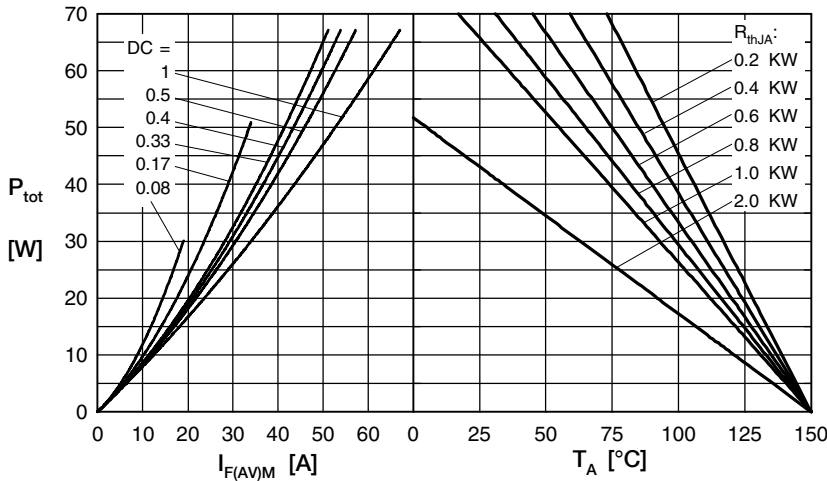

Fig. 4 Power dissipation vs. forward current and ambient temperature per diode

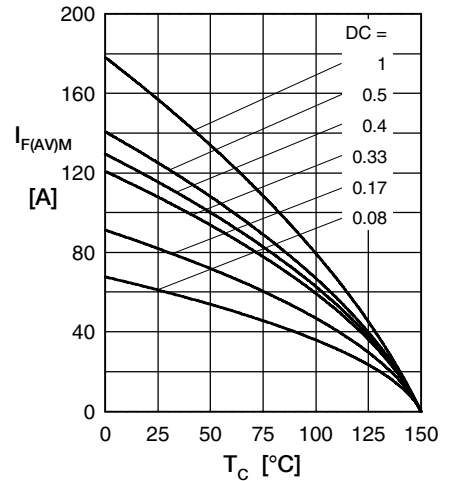

Fig. 5 Max. forward current vs. case temperature per diode

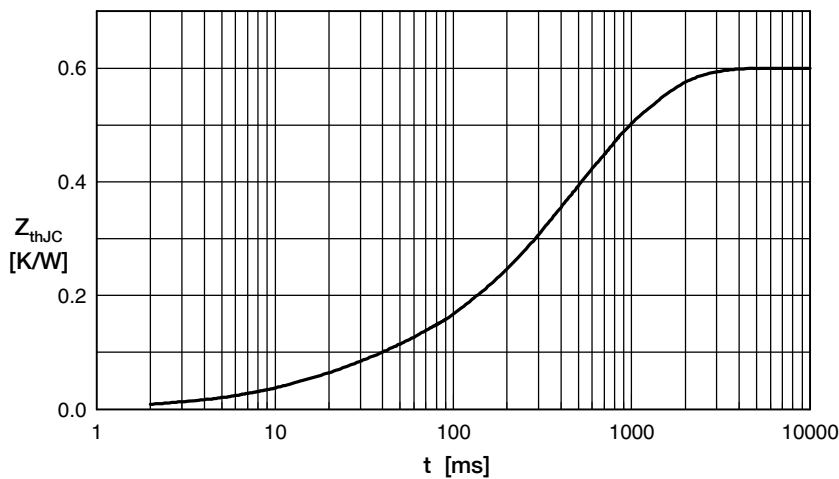

Fig. 6 Transient thermal impedance junction to case vs. time per diode

Constants for Z_{thJC} calculation:

i	R_{th} (K/W)	t_i (s)
1	0.060	0.020
2	0.003	0.010
3	0.150	0.225
4	0.243	0.800
5	0.144	0.580